

MY CHILD[®]

Hamilton Car Seat

Group 0,1 child car seat



This product conforms to ECE R44.04

Group 0,1 child car seat.

Suitable for children from 0kg to 18kg (approx 0 to 4 years old)

Instructions: Please read carefully and keep for future reference. Your child's safety may be affected if you do not follow these instructions.

NOTICES

1. The child car seat must only be used in vehicles which are fitted with a three point seatbelt system that has been approved by regulation ECE-16 or similar.
 2. A correct fit is likely if the vehicle manufacturer has declared in the vehicle hand book that the vehicle is capable of accepting a 'Universal' child restraint for this group.
 3. The child car seat is a 'Universal' child restraint; it conforms to regulation ECE-R44/04 for general use in vehicles. It will fit most, but not all vehicle seats.
 4. This child car seat has been declared 'Universal' under more stringent conditions than those applied to earlier designs, which do not carry the 'Universal' mark.
 5. Child car seats can mark vehicle seat upholstery. The manufacturer cannot be held responsible for damage or marking to vehicle seats.
 6. The following situations could be illegal and will invalidate the warranty:
 - a) Any modifications or change of use of the child car seat that have not been authorised or advised by the manufacturer.
 - b) Any failure to fit the child car seat in strict accordance with the instructions.
- The manufacturer accepts no liability for issues arising from unauthorised modifications, uses or fitting.
7. Please keep this manual safe for any possible queries you may have in the future.
 8. You will need to keep your proof of purchase. We recommend you keep them together.

Getting started

Read Carefully Before Attempting to Fit the Child Car Seat

Warning: NEVER leave your child unattended – your child's safety is your responsibility.

Warning: The child car seat must be fitted in accordance with the manufacturer's instructions. Incorrect installation could be dangerous.

Warning: This installation must only be performed by a competent adult. Don't try to install the seat when intoxicated or drowsy.

Warning: Always ensure that new or occasional users [e.g. grandparents] have read the instructions or been taught the correct installation by someone who has read and understood the instructions.

Warning: Always keep this instruction manual with the child car seat, or in the vehicle in which you are carrying the child car seat. Some models of child car seat have a pocket to store the instructions.

Before starting

Warning: Do not fit the child car seat on a side or rear facing vehicle seat.

Warning: Before installing the child car seat ensure that the passenger seat you are using is locked in the upright position.

Warning: Do not use the child car seat in the home - it has only been designed to be used in the car.

Warning: Do not leave loose/unsecured objects on the back seat of your car or the parcel shelf. They may be dangerous to your child if you are forced to brake suddenly.

**EXTREME HAZARD
NEVER USE IN FRONT PASSENGER SEATS EQUIPPED WITH
AIRBAGS (SRS)
THIS CAN INCLUDE REAR PASSENGER SEATS THAT ARE
EQUIPPED WITH AIRBAGS***

***Consult car manufacturer for suitability. Children's bodies are not able to withstand the forces exerted on them by a deploying air-bag**

When using the child car seat

Warning: Make sure that the child car seat is placed somewhere so that rigid items and plastic parts do not become trapped in doors or movable seat units when the seat is in everyday use.

Warning: Always use the vehicle's door child safety lock system, if one is available, to make it impossible for the child to open the car doors from inside.

Warning: Allow the child a break during long car journeys and make sure they don't get out of the car unaided and without supervision.

Warning: The child car seat must be fitted securely to the passenger seat. Ensure that it is not loose or wobbly after you have fitted it. If it is loose, re-fit it.

Warning! Do not use any load bearing contact points other than those specified in these instructions and marked on the child restraint.

Warning: The child car seat must not be used without its original cover. The original cover is essential for the safe operation of the child car seat.

Warning: Stop the car at regular intervals to check that the child car seat is in the correct position and that both the car seatbelt **AND** the child car seat harness are still taut and latched.

Warning: In the event of an emergency it is important to be able to release the child quickly (as defined by British Standards). This means that the seat buckle cannot be fully tamper proof and you should actively discourage your child from playing with or using the buckle.

Warning: If you travel with passengers using both the front and the rear passenger seats, the lighter occupants should be in the rear and the heavier occupants in the front.

Warning: If you have no option other than to put your child car seat on a rear passenger seat next to side airbags:

- Consult with your vehicle manufacturer for side airbag details. It may not be safe.

- Make sure your child does not lean into the area immediately

around the airbag.

Warning: Do not place anything under the child car seat (e.g. a towel or cushion) as this could affect the performance of the seat in an accident.

Warning: Avoid winter clothing bundling - Bulky clothing can lead to incorrect harness tightening. In an accident, the child can slip right out of the extra padding - and thus out of the seat. Let the car warm up or cool down prior to placing your child in there if possible. If your child is cold, place a blanket over the top of the harness.

Seatbelt

Warning: NEVER use any load bearing contact points other than those described in these instructions or marked on the child car seat.

Warning: Ensure that the lap section of the harness is worn low down, so that the pelvis is firmly engaged.

Warning: Make sure that **ALL** the passengers in your vehicle have their seatbelts fastened, as unrestrained people can be very dangerous to the child in an accident.

Warning: NEVER use a seatbelt routing scheme that differs from these instructions.

Warning: The harness must be used at all times when your child is in the child car seat.

Warning: If you are installing the child car seat using a seatbelt ensure there are no twists in the seatbelt.

Back of the seat/headrest

Warning: Ensure that the child car seat is as close as possible to the backrest of the car seat.

Warning: REMOVE the headrest of the passenger seat being used if it obstructs the proper installation of the child car seat. **REMEMBER** to refit the headrest when the child car seat has been removed.

Sunlight/hot days

Warning: Don't leave your child in the child car seat while parked in direct sunlight or on a hot day.

Warning: Do not subject the child car seat to prolonged direct sunlight as this may be dangerous for your child (the metal and plastic fittings could become hot) and may cause the fabric to fade. You can reduce this problem by covering the child car seat with a sheet when not in use.

Second hand or damaged child car seats & seatbelts

Warning: Never buy a second hand child car seat. It may have unseen damage.

Warning: The manufacturer only guarantees this product when the original owner uses it.

Warning: You **MUST** replace the child car seat and your vehicles seatbelts if they becomes badly worn or damaged.

Warning: You **MUST** replace the child car seat if it is involved in an accident – it may have unseen damage and may not protect your child as well as they should. At the very least send the child car seat to the manufacturers for inspection, together with the accident report.

Contents

General safety information - READ FIRST	2-6
Welcome	7
Parts checklist	8-9
Positioning the child car seat	10
Installing the seat - rearward facing for use with group 0 [0-10kg]	11-14
Installing the seat - forward facing for use with group 1 [9-18kg]	15-18
Placing your child in the seat	19-20
Adjusting the harness height	21-23
Removing the seat cover	23-24
Replacing the seat cover	25-26
Maintenance and cleaning	27

Your 3 year warranty

Whilst we make and test our products to the highest standards of durability there's always a small chance of a hiccup! Our promise is to repair, replace or refund a MyChild product that has an identified manufacturing defect from the date of purchase for a full 3 years thereafter at no extra cost.

However, you must register within 28 days of the date of purchase to receive the full 3 years guarantee!

To receive your full guarantee you can register your product by: visiting www.mychildonline.co.uk/warranty.html and complete the warranty form, or by telephone on 0161 335 2508.

Welcome

Thank you for purchasing the Hamilton Car Seat.

Please read these instructions carefully before use to ensure safe and satisfactory operation of this product.

Your child's safety is your responsibility. If you have a query with this product or require replacement parts, please contact your nearest MyChild retailer.

Parts checklist

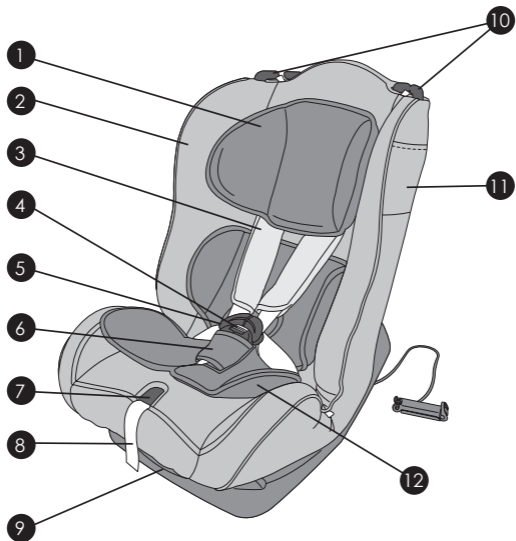

- | | | | |
|---|------------------------|----|---|
| 1 | Head cushion | 7 | Harness adjuster button
(under seat cover) |
| 2 | Seat cover | 8 | Harness adjuster strap |
| 3 | Shoulder pads & straps | 9 | Seat recline adjuster |
| 4 | Harness release button | 10 | Shoulder belt guides |
| 5 | Harness buckle | 11 | Instruction manual pocket |
| 6 | Buckle pad | 12 | Cushion insert |

Parts checklist

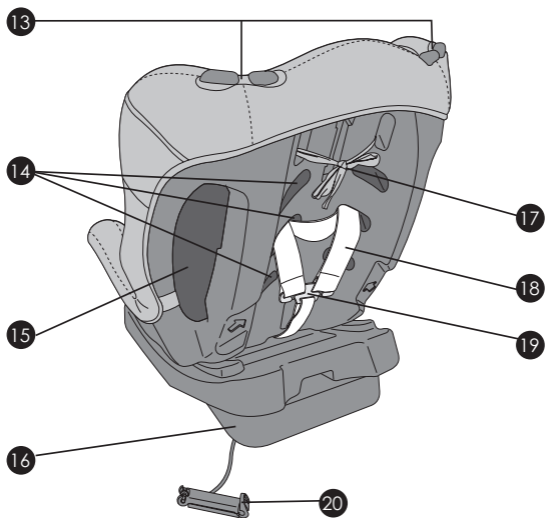

- | | | | |
|----|--------------------------------|----|---------------------|
| 13 | Shoulder belt guides | 17 | Head cushion ties |
| 14 | Shoulder strap height settings | 18 | Shoulder straps |
| 15 | Seatbelt channel opening | 19 | Shoulder strap yoke |
| 16 | Angle block | 20 | Red safety clip |

Positioning the child car seat

The child car seat can only be used with an automatic 3-point safety belt (A) and **NOT** with a 2-point lap belt (B).

If your centre rear passenger seat is fitted with a three point seatbelt system (A) then you should use it.

If your centre rear passenger seat does not have a three point seatbelt system (i.e. no seatbelt at all, or only a lap belt (B)) - then you should use the rear left passenger seat or the rear right passenger seat.

The front passenger seat can only be used if it **DOES NOT** have an airbag and **IS** fitted with a three point seatbelt system.

WARNING: Never use on rearward or side facing vehicle seats

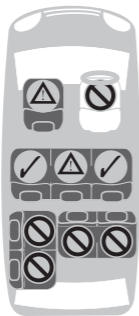
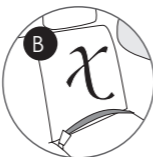
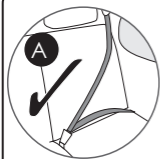

Front passenger seat (no active airbag)	Yes
Front passenger seat (active airbag)	NO
2-point seatbelt	NO
3-point seatbelt	Yes
Back left & right seats	Yes
Back centre seat (3-point seatbelt)	Yes
Back centre seat (2-point seatbelt)	NO
Side facing seats	NO
Rear facing seats	NO

Installing the seat - rearward facing

For use with group 0 [0-10kg]

WARNING! Do not try to fit the child seat using any part of the child seat that is not specifically designed to hold it in place. The instructions and the fitting picture (on the side of the child seat) specify the correct parts of the child seat to attach fitting devices (e.g car seats and ISOFIX points). Do not attempt to use any other part of the child seat to hold it in place, and always ensure that you use the exact fitting method that is specified.

ATTENTION! Rear facing car seats are 300% safer than forward facing car seats. Only consider changing the child seat to a forward facing child seat when the child has completely outgrown the rear facing mode. Your child has outgrown the rear facing mode when they are over 10kg or too big to fit in the seat when it is rear facing.

It will soon be a legal requirement for all children to be kept in a rear facing child seat until they are 15months old. We strongly advise that you keep your child in a rear facing child seat until they are at least 15months old.

For use with group 0 [0-10kg]

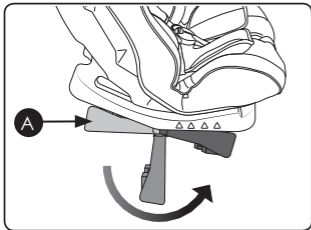

Rotate the angle block (A) on the underside of the child car seat to the front. You may need to pull quite firmly to release the block from its locked position.

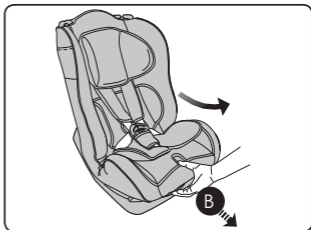

Adjust the seat to its most reclined position by squeezing the red recline adjuster handle (B) and pulling the child car seat forward as far as possible.

Installing the seat - rearward facing (continued)

For use with group 0 [0-10kg]

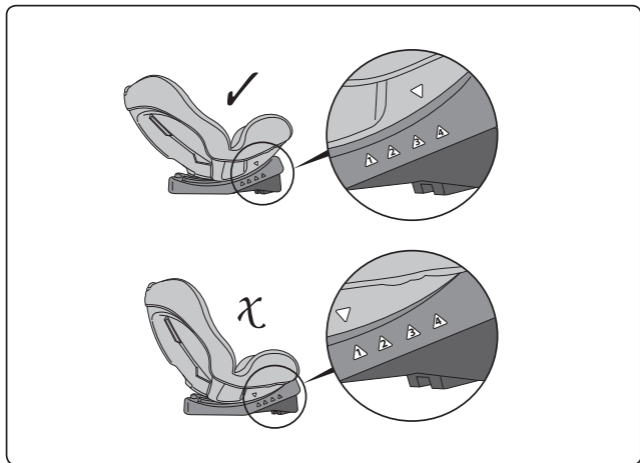

Attention: The child car seat must be in its most reclined position (4) when rearward facing.

Note: If seat will not recline to position (4) check that block (A) is fully forward.

Installing the seat - rearward facing (continued)

For use with group 0 [0-10kg]

Place the child car seat in the vehicle on a suitable forward facing passenger seat. Pull out approximately a metre of seatbelt and route the lap belt section across the seat and buckle up the seatbelt (C).

Note: Ensure the lap section is routed under the cushion insert if it is being used.

Pull the diagonal section of seatbelt through the shoulder belt guide slot (D) nearest to the shoulder belt anchor point (E) and wrap the shoulder belt around the back of the seat.

Push the child seat tight into the vehicle seat and at the same time pull the lap and diagonal belts tightly towards the shoulder belt anchor point (E), ensuring all slack is removed.

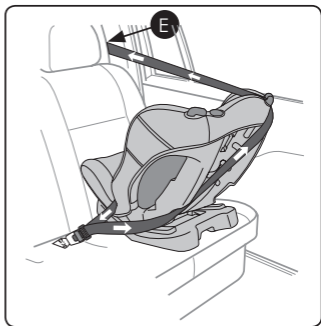
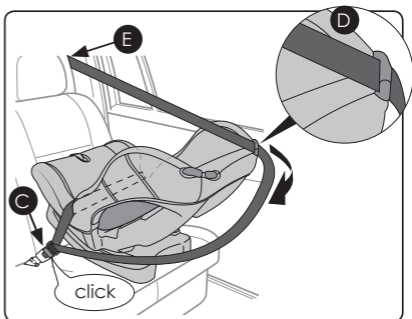

Installing the seat - rearward facing (continued)

For use with group 0 [0-10kg]

Attach the belt clip (F) to the diagonal shoulder belt as close as you can to the seat buckle without the clip actually touching the buckle.

NOTE: Do not attempt to attach the clip to both belts, it should only be attached to the diagonal shoulder belt.

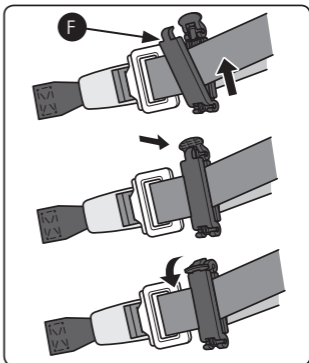

1. Check! The vehicle seatbelt has been pulled tight and is not twisted.

2. Check! The child car seat is firmly fitted on the vehicle seat and that the two are pushed tightly together.

3. Check! The belt clip has been closed properly.

4. Check! The seatbelt tongue has been correctly inserted into the seat buckle.

5. Check! The child car seat is in its fully reclined position.

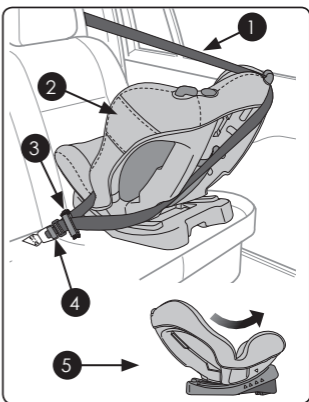

Installing the seat - forward facing

For use with group 1 [9-18kg]

WARNING! Do not try to fit the child seat using any part of the child seat that is not specifically designed to hold it in place. The instructions and the fitting picture (on the side of the child seat) specify the correct parts of the child seat to attach fitting devices (e.g car seats and ISOFIX points). Do not attempt to use any other part of the child seat to hold it in place, and always ensure that you use the exact fitting method that is specified.

ATTENTION! Rear facing car seats are 300% safer than forward-facing car seats. Only consider changing the child seat to a forward facing child seat when the child has completely outgrown the rear facing mode. Your child has outgrown the rear facing mode when they are over 10kg or too big to fit in the seat when it is rear facing.

It will soon be a legal requirement for all children to be kept in a rear facing child seat until they are 15months old. We strongly advise that you keep your child in a rear facing child seat until they are at least 15months old.

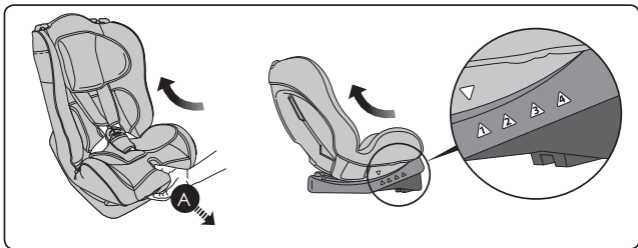

Adjust the seat to its most upright position by squeezing the red recline adjuster handle (A) and pushing the child car seat backward.

Installing the seat - forward facing (continued)

For use with group 1 [9-18kg]

Rotate the angle block (B) on the underside of the child car seat to the back and click it into place.

IMPORTANT: If you cannot easily click the block into place, check that the seat is NOT still in position 4.

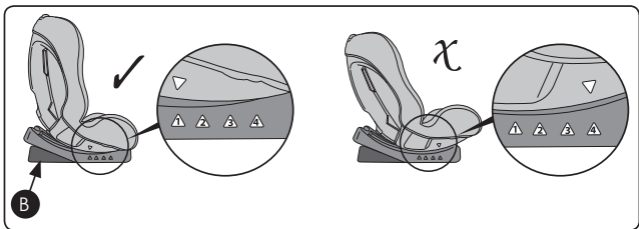
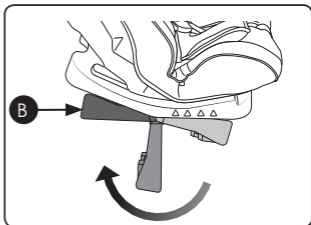

Check that the angle block (B) is folded back under the child car seat and that the seat is in its most upright position 1

Installing the seat - forward facing (continued)

For use with group 1 [9-18kg]



Place the child car seat in the vehicle on a suitable forward facing passenger seat.

Push the child seat tight into the vehicle seat* and at the same time pull the lap and diagonal belts tightly ensuring all slack is removed.

*If possible kneel on the child seat and push it tight into the vehicle seat.

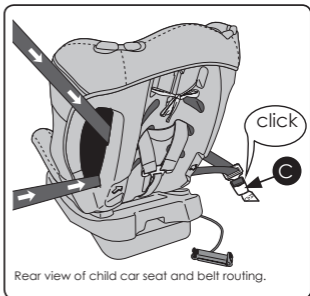

Thread the seatbelt tongue through the opening on the side of the child car seat, out the opposite side and fasten the seatbelt into the seatbelt buckle (C).

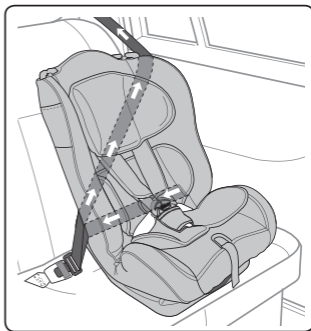

Installing the seat - forward facing (continued)

For use with group 1 [9-18kg]

Attach the belt clip (D) to the diagonal shoulder belt as close as you can to the seat buckle without the clip actually touching the buckle.

NOTE: Do not attempt to attach the clip to both belts, it should only be attached to the diagonal shoulder belt.

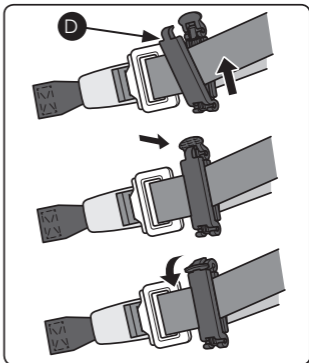

1. Check! The vehicle seatbelt has been pulled tight and is not twisted.

2. Check! The vehicle seatbelt has been fed through the openings on each side of the child car seat.

3. Check! The belt clip has been closed properly.

4. Check! The seatbelt tongue has been correctly inserted into the seat buckle.

5. Check! The child car seat is pulled back into the vehicle seat and that the two are pushed tightly together.

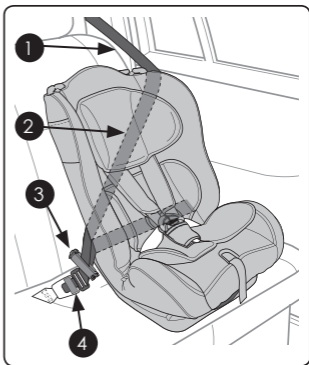

Placing your child in the child seat

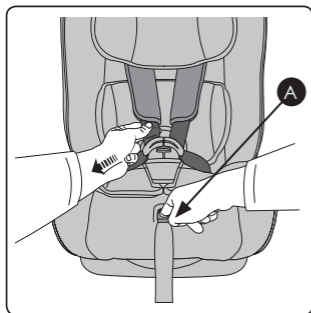

Press the harness adjuster button (A) and pull forward on the shoulder straps (not the shoulder pads) to completely loosen the harness.

With the harness straps over the sides of the child car seat place your child in the seat.

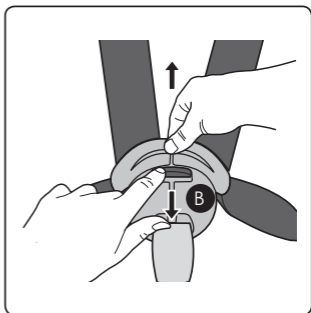

Press the red button (B) on the buckle and unfasten the harness.



Placing your child in the child seat

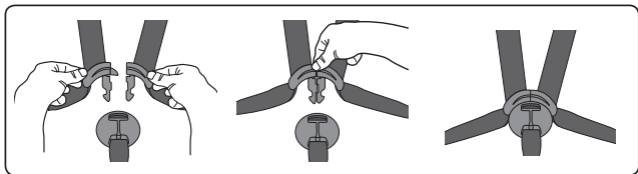

With your child in the seat, match the two halves of the harness buckles together and insert them into the crotch buckle until you hear a click.

Make sure the shoulder straps fit your child snugly by pulling the adjuster belt (C).

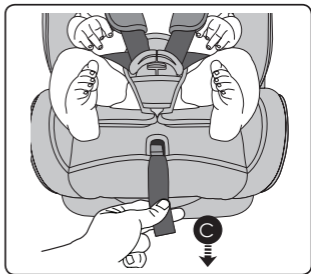

The harness should allow 1 finger width (1cm) of space at the top of the shoulders. This is the ideal tightness. If the harness is too loose or too tight then adjust the height or tightness accordingly.

WARNING: The child car seat should always be strapped in using the vehicle's seatbelt whether a child is seated in the child seat or not.



Adjusting the harness height



The harness should exit the child car seat at the same height as the child's shoulder and should not exit higher or lower than the child's shoulder.

WARNING: You should not attempt to adjust the harness height with a child seated in the child car seat.

Untie the head cushion (A) and remove.

Press the harness adjuster button (B) and pull forward on the shoulder straps (not the shoulder pads) to completely loosen the harness.

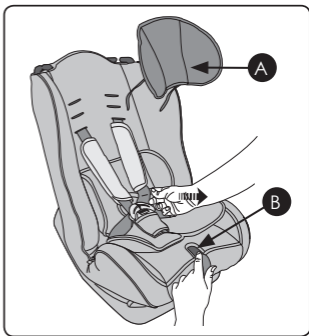

Adjusting the harness height (continued)

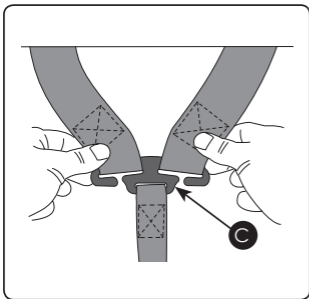

Unhook the shoulder straps at the rear of the seat shell by sliding the straps through the slits in yoke (C).

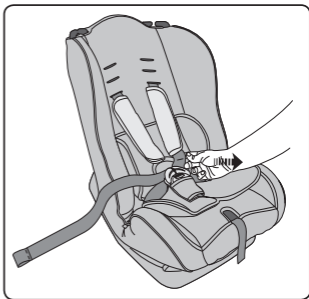

Remove the straps, pulling them out from the front of the seat.

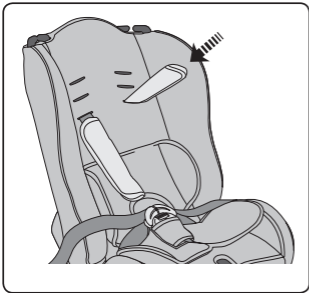

Thread both shoulder pads through the slots in the back of the seat and remove them.

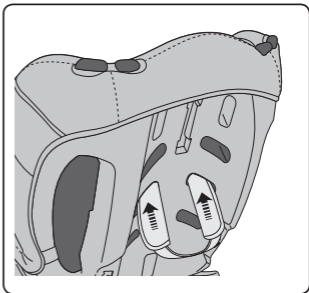

Push the shoulder pads back through the seat at your desired slot height.

Adjusting the harness height (continued)



Thread the shoulder straps through each shoulder pad and pass the shoulder straps through the same slots as the shoulder pads.

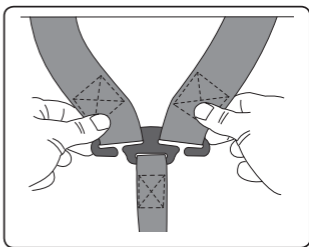

Reconnect the shoulder straps to the yoke and check all straps are passing through at the same slot height, then reattach the head cushion.

Removing the seat cover

WARNING: The cover is a safety feature. Never use the child car seat without it.

The seat cover can be removed for hand washing (see "maintenance and cleaning" page 27).

Untie the head cushion (A) and remove.

Press the harness adjuster button (B) and pull forward on the shoulder straps (not the shoulder pads) to completely loosen the harness. Unfasten the buckle and remove the buckle pad and cushion insert.

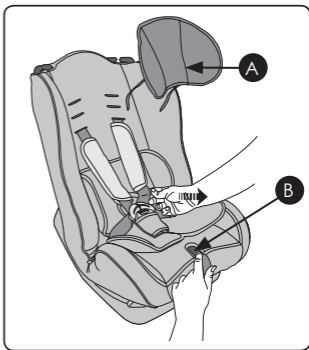

Removing the seat cover (continued)

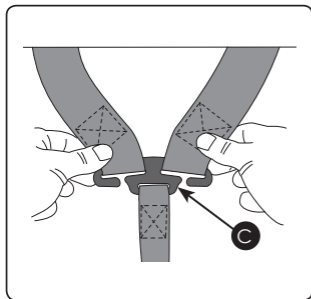

Unhook the shoulder straps at the rear of the seat shell by sliding the straps through the slits in yoke (C).

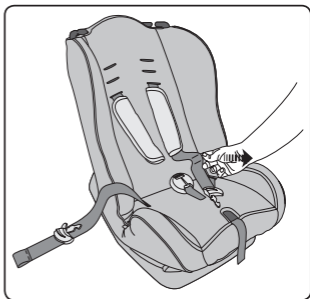

Remove the straps, pulling them out from the front of the seat.

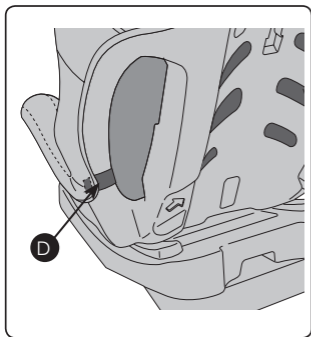

Unfasten the Velcro tabs (D) on both sides of the seat.

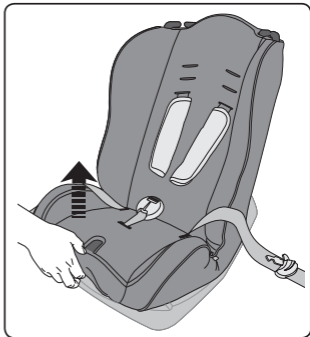

Carefully loosen the cover from the shell starting at the bottom of the seat. Pass all buckles and straps through the cover and remove the cover.

Replacing the seat cover

Pass both shoulder straps through the two side slots (A) in the seat cover. Thread the crotch strap through the slot (B) in the centre of the seat cover base and pass the harness adjuster strap through the hole (C) at the front of the seat cover base.

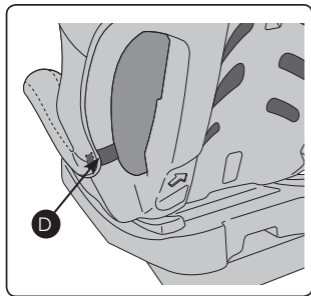
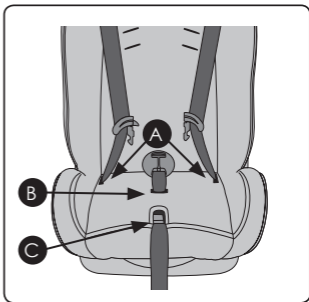

Place the cover around the shell and fasten Velcro tabs (D) on both sides of the seat.

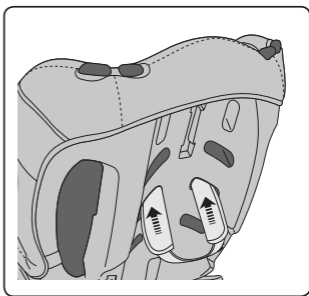

Push the shoulder pads back through the seat at your desired slot height.

Replacing the seat cover (continued)

Place the crotch pad (E) over the buckle.

Fasten the buckle (this will help prevent the straps twisting).

Thread the shoulder straps (F) through the shoulder pads (G) (keeping the seams on the shoulder pads outwards).

Thread the shoulder straps through the child seat at the same height as the shoulder pads.

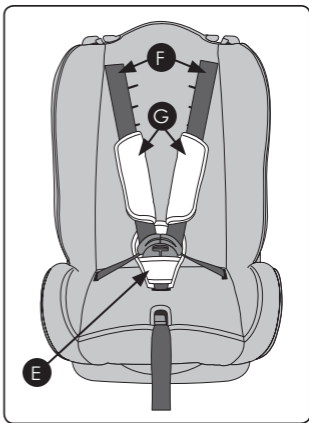

Reconnect the shoulder straps to the yoke (H) on the rear of the seat ensuring the straps are not twisted.

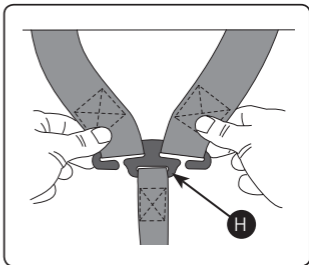

Maintenance and cleaning

Storage

- 1) Store this child car seat in a safe place when not in use.
- 2) **DO NOT** place heavy objects on top of it.
- 3) Always store the child car seat in a dry environment.
- 4) **DO NOT** store the child car seat near a direct heat source such as a radiator.

Cover

- 1) The seat cover is easily removable and should be hand washed with a pH neutral soap and cold water.
- 2) Do not press, iron, dry clean, tumble dry or wring the covers.
- 3) Do not use solvents, caustic or abrasive cleaning materials.
- 4) Dry flat, away from direct heat and sunlight.
- 5) If the seat covers need to be replaced only use parts certified by the manufacturer. They are the only ones that are guaranteed to have been safety tested and designed to fit this seat.

Plastic/Metal Parts

- 1) Wipe clean using a mild soap and warm water.
- 2) You must not remove, dismantle or alter any part of the seat shell.
- 3) You must not oil or lubricate any part of the seat shell.

Inspection

- 1) Check your child car seat regularly for wear and tear.
- 2) The child car seat may have a slight rattle when not in use, this is normal. If in any doubt, contact MyChild immediately.
- 3) Check the adjustable parts of your child seat at intervals of about 6 months to ensure it is still fits correctly for your growing child.



Customerservice@kooltrade.co.uk
Imported by MyChild. M34 3QA
www.mychildonline.co.uk
Tel: 0161 335 2508